

Kratzer im Rahmen /
scratches on the frame

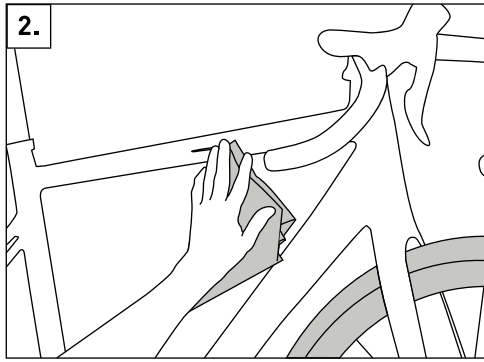

Fettfreie Reinigung /
grease free cleaning

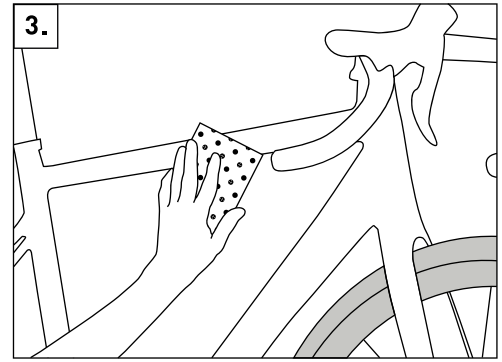

**Schleifen Sie die Stelle des Kratzers ggf. mit
sehr feinem Schleifvlies (Körnung 600) ab /**
If necessary, grind the place of the scratch with
very fine abrasive fleece (grit 600)

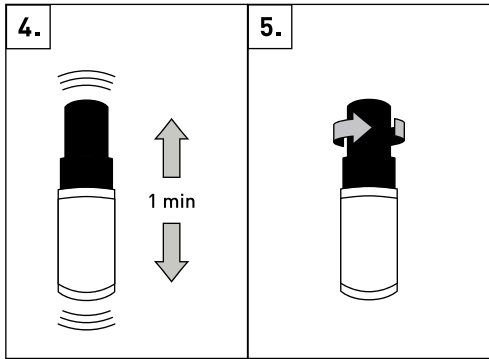

Schütteln des Lackstiftes und vorsichtig öffnen /
shake the touch-up pencil and open it carefully

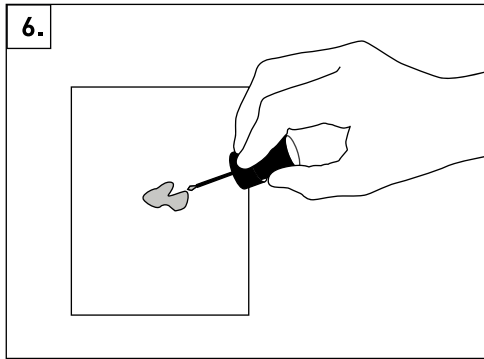

Farbechtheit prüfen z.B. auf Karton /
check the color fastness e.g. on cardboard

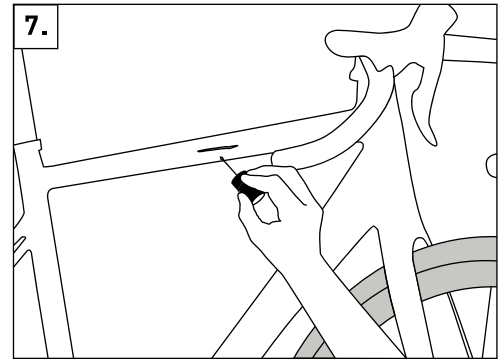

Lack auftupfen /
dab on varnish

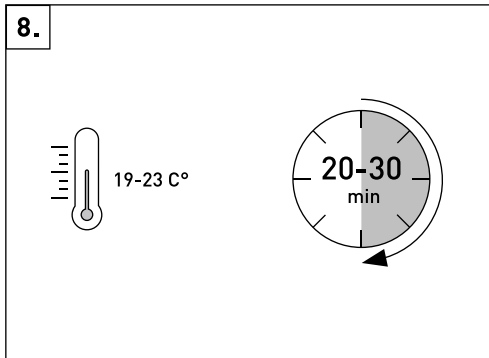

**20-30 Minuten bei Raumtemperatur trocknen
lassen /**
allow to dry for 20-30 minutes at room temperature

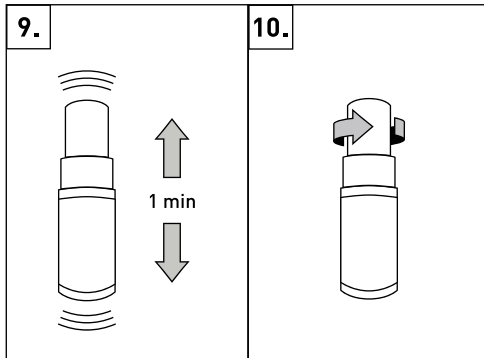

Schütteln des Klarlackes und vorsichtig öffnen /
shake the clearcoat and open carefully

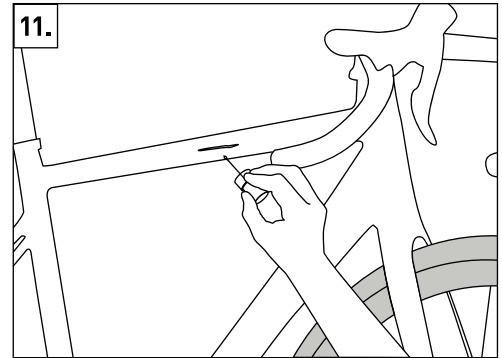

Klarlack auftupfen /
dab on varnish

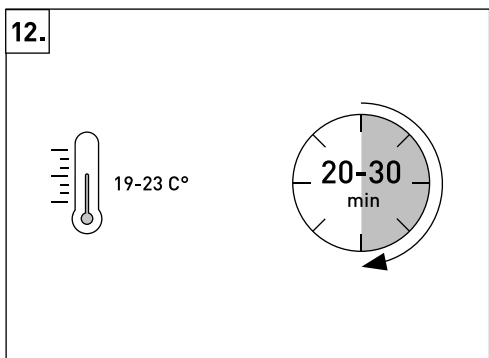

**20-30 Minuten bei Raumtemperatur trocknen
lassen /**
allow to dry for 20-30 minutes at room temperature

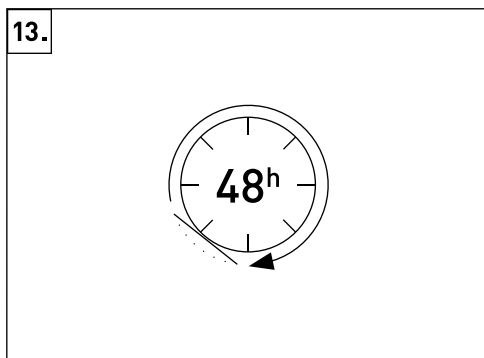

48h Aushärten lassen /
allow to cure for 48 hours

HINWEIS / NOTICE:
Es können Farbabweichungen auftreten!
Color deviations may occur!



Gefahr - Danger - Pericolo - Peligro -
Gevaar - Perigo - Fare - Vaara - Fara -
Nebezpečí - Opasnost - Nevarno

CUBE

PENDING SYSTEM GMBH & CO. KG
Ludwig-Hüttner-Str. 5-7
D-95679 Waldershof